



DB500[®] User Manual

Warning: Do not use this equipment until you have read the manual and understand the contents. *User safety is always a top priority. However, the safety of an intended user can only be protected if outlined precautions are read and followed carefully. *International Distributors are responsible for the proper translation of this manual.



TABLE OF CONTENTS

I. Introduction	4
Notice Symbols	4
Blast Pot Warranty	5
Safety Overview	6
II. Abrasives	7
Selecting an Abrasive	7
<i>Abrasive shape</i>	7
<i>Abrasive size, density, and hardness</i>	7,8
Media Comparison Charts	8
<i>Figure 3. Dry Blasting Abrasive</i>	8
<i>Figure 4. Wet or Dry Blasting Abrasive</i>	9
Abrasive Fill Levels	10
III. Preparing to Blast	11
Personal Protective Equipment	11
Masking and Containment	11
Model DB500®	12
IV. Blast Pot Start Up	13
i. Connect the Blast Hose, Compressor Air Hose, and Lines to the Blast Pot	13
ii. Fill the Blast Pot with Abrasive and Water	14
iii. Turn on the Compressor	15
iv. Pressurize the Blast Pot	15
V. Active Blasting	16
Begin Blasting	16
VI. Blast Pot Shut Down	17
VII. In Process Adjustments	18
Adjusting Abrasive Flow Rate	18
<i>Increasing media flow</i>	18
<i>Decreasing media flow</i>	19
Adjusting Operating Pressure	19
Adjusting Blast Distance	19
VIII. Transitioning from Wet to Dry Blasting	20
Machine Transportation	20
Moving the Blast Pot	20

- IX. Machine Storage**.....21
 - Storing the Machine in Cold Climate**.....21
 - Blasting in Freezing Temperatures**.....21

- X. Maintenance**.....22
 - Control Box**.....22
 - Pressure regulator*.....22
 - Control box Parker valve*.....22
 - Blast Pot Pressure Regulator**.....23
 - Filter Regulator**.....23
 - Blast Hose**.....23
 - General Blast Pot Maintenance**.....24
 - Flushing the blast pot*.....24
 - Blast wear parts*.....25
 - Pinch Hose Maintenance**.....26
 - Using the pinch hose*.....26
 - Removing the brass couplings from an old hose*.....27
 - Attaching the brass couplings to the new pinch hose*.....27
 - Preventative Maintenance**.....28
 - Daily maintenance*.....28
 - Weekly maintenance*.....28
 - Monthly maintenance*.....29

- XI. Troubleshooting**.....30
 - Media Buildup Inside the Blast Pot**.....30
 - Adjust the vibrator valve*.....30
 - Abrasive Flowing Incorrectly**.....30
 - Check installation and air pressure*.....30
 - Check media quality*.....30
 - Nothing Coming from the Blast Nozzle**.....30
 - Pinch Valve is Not Opening or Closing (Electric)**.....30
 - Pinch Valve is Not Opening or Closing (Pneumatic)**.....31

- XII. Appendix**.....32-35

I. INTRODUCTION

This manual covers the start up, operation, storage, maintenance, and troubleshooting, for a DB500® blast pot. Intended users must read and understand the contents of the instructions before operating their machine and its accessories. The intended user should be able to safely operate the blast machine and be aware of the hazards associated with blasting.

Proper personal protective equipment is required for the operator and any supportive personnel. This includes but is not limited to hearing protection, eye and face protection, helmet, leather gloves protecting the full forearm, safety shoes or boots. To protect from dust inhalation, NIOSH-approved air fed respirators with at least Grade D breathing air is required.

The blast pot is ASME, NB, CE, and/or PED certified. Welding, grinding, or drilling on the pot voids the National Board certification and manufacturer's warranty. Such actions may affect the dimensional integrity of the blast pot. The user should install a required safety relief valve to prevent the rise of pressure no more than ten percent of the set MWP as required by ASME section VIII, Div. 1. The design maximum and minimum parameters shall not be exceeded. See the parameters in Figure 1 below. Be sure to read all warnings listed on the blast pot before operation. See Figure 1.1 below for more information.

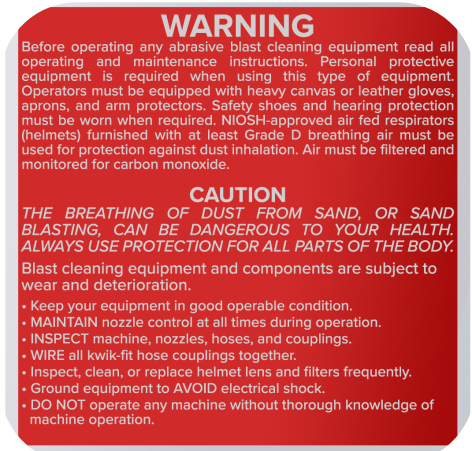
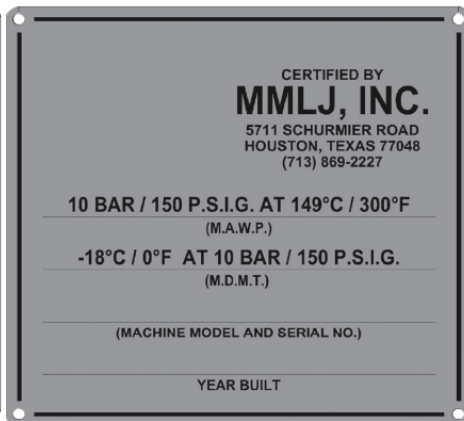
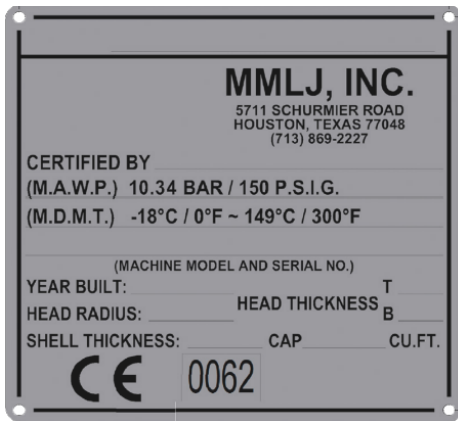

Figure 1. Name plates

Figure 1.1 Blast pot warning label

Notice Symbols

For operator safety and machine preservation, please pay careful attention to the special notices listed in this manual.

Note

A point of emphasis or reminder for operator. Can also indicate potential for minor problems

Caution

Potential for damage to equipment or problems in the outcome if statement is not closely followed

Warning

Possibility of minor injury to operator or bystanders



DANGER

Possibility of serious or fatal injury to operator or bystanders

Blast Pot Warranty

MMLJ, Inc. Limited Warranty

Terms of Warranty

MMLJ, Inc. warrants the product you have purchased is free from defects in materials or workmanship under normal use during the warranty period. Your sales receipt, showing the date of purchase for this product, is your proof of the date of purchase. This warranty is valid only if the product is assembled/installed according to the instructions included with the product. This warranty extends only to you, the original purchaser. It is not transferable to anyone who subsequently purchased the product from you.

During the warranty period, MMLJ, Inc. will repair or replace (at MMLJ, Inc.'s option) the product if it becomes defective or otherwise fails to conform to this Warranty under normal use. In repairing the product, MMLJ, Inc. may replace defective part with new, or at the option of MMLJ, Inc., serviceable used parts that are equivalent to new parts in performance. MMLJ, Inc. reserves the right to change manufacturers of any part to cover any existing warranty. This extends to items normally covered by a manufacturer other than MMLJ, Inc. used on this product within the first calendar year of purchase.

This warranty does not cover shipping charges, export taxes, custom duties and taxes, or any other charges associated with transportation of the parts or products. To obtain warranty service, you must contact MMLJ, Inc.'s customer service representatives. Any parts determined to be defective must be brought to the attention of MMLJ, Inc. within six months of delivery of equipment. You must prepay any shipping charges, export taxes, custom duty taxes, or any other charges associated with transportation of the parts or product. In addition, you are responsible for insuring any parts or product shipped or returned. You assume the risk of loss during the shipment. You must present MMLJ, Inc. with proof-of-purchase documents (including the date of purchase). Any evidence of alteration, erasure, or forgery of proof-of-purchase documents will be cause to void this warranty.

The warranties listed above do not extend to any product that has been damaged or rendered defective (a) as a result of accident, misuse, or abuse (b) by the use of parts not manufactured or sold by MMLJ, Inc. and/or (c) by modification or improper installation of the product. Product on which the serial number has been defaced or removed is not eligible for warranty service. Should any product submitted for warranty service be found ineligible, an estimate of repair cost will be furnished and the repair will be made if requested by you upon MMLJ, Inc. receipt of payment or acceptable arrangements for payment. Except, as expressly set forth in this warranty, MMLJ, Inc. makes no other warranties, expressed or implied. This is the only express warranty applicable to Dustless Blasting® branded products. MMLJ, Inc. does not assume, nor authorize anyone to assume for it any other express warranty.

Blast Pot Limited Lifetime Warranty

This warranty applies only to pressure vessels manufactured by MMLJ, Inc. under the Dustless Blasting® brand name. This product is backed by a limited lifetime warranty, excluding only expendable parts such as gauges and valves (which are covered by manufacturer other than MMLJ, Inc.) and paint. This Limited Warranty does not extend to any product that has been damaged or rendered defective (a) as a result of lack of maintenance, accident, misuse, or (b) abuse by the use of parts not manufactured or sold by MMLJ, Inc. and/or (c) by modification or improper installation of the product.

Third Party Warranties

For parts that are not covered by MMLJ, Inc., please contact our office and report the defect. MMLJ, Inc. will then proceed with the warranty process for the affected item on your behalf. All items not covered by MMLJ, Inc. will fall under a limited one year warranty free of manufacturer defects.

For more warranty information, visit www.DustlessBlasting.com/legal/warranties.

Please call our office for any questions on warranties or warranted items.

Toll Free: 800-717-5707 International: +1 713-869-2227 Email: Support@DustlessBlasting.com

Safety Overview

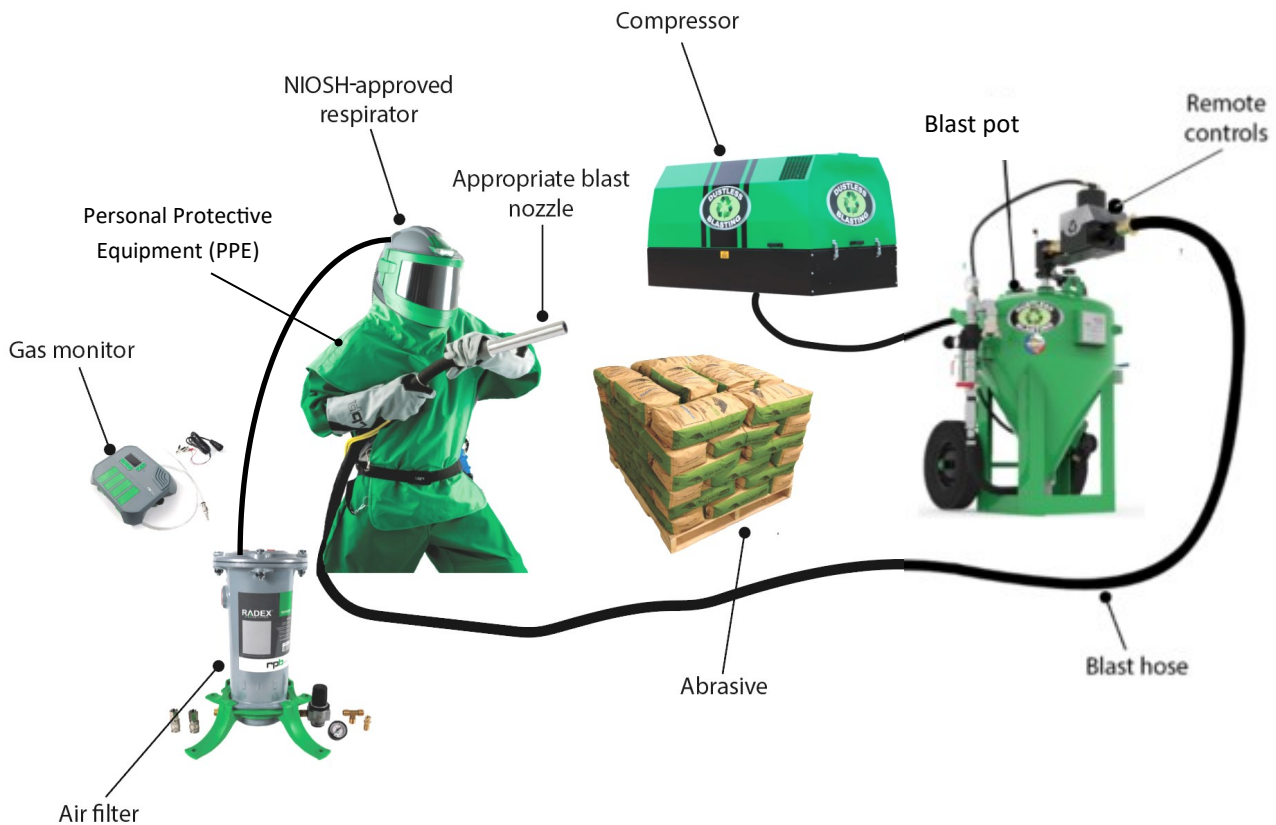

Remote controls. Never attempt to bypass the remote (safety) controls on the blast pot setup. A few important safety points to ensure are in proper working condition are the deadman control, pinch valve, and pinch hose.

Air filter. Used with NIOSH-approved respiration equipment to remove air contaminants. Follow the manufacturer's requirements for replacing these filters as necessary. Air filter does not detect or remove carbon monoxide.

Gas monitor. When using a respirator, always be sure to have a working gas monitor. This helps to protect against potential for carbon monoxide poisoning and monitoring levels of other gases, such as oxygen, with the operator's NIOSH-approved respirator.

NIOSH-approved respirator. Respirators can only give a satisfactory level of protection when they are selected, fitted, used, and maintained according to the manufacturer's written instructions, NIOSH guidelines, and OSHA requirements. Replace helmet lens and filters frequently.

Appropriate blast nozzle. Check the nozzle for wear before use. Be sure the selected nozzle is appropriate for the amount of air pressure in use.

Abrasive. Media must be suitable for blasting and the conditions the operator chooses to blast in i.e. wet or dry blasting. Do not use abrasives with more than one percent crystalline silica. Be sure to check an abrasive's Safety Data Sheet for more information on media contents.

Blast pot. The DB500[®] is designed to blast for approximately 60 minutes. Inspect the machine, nozzles, hoses, and couplings before operating. Make sure to ground the equipment before use to avoid the risk of electrical shock. Wire all kwik-fit couplings together. Keep the machine in safe, operable condition. Read all warnings on the pot before operation.

Compressor. Air compressor should be properly maintained and sized to provide adequate CFM for the tools in use. Excessive compressed air pressure can cause a blast machine to rupture. Be sure to read and understand the compressor user manual before use.

Blast hose. Avoid crimping the blast hose when using. Check the hose for wear before use. Make sure all safety pins are in place when attaching a blast hose. Pressure can cause the hose to disconnect and can inflict serious injury or death.

Protective Equipment (PPE). Follow all OSHA guidelines for PPE before, during, and after the blasting process.

II. ABRASIVES



DANGER: No dust is safe to breathe. Abrasives may contain toxic materials that are hazardous to persons in the blasting area when inhaled.

Do not use abrasives containing more than one percent crystalline (free) silica. Inhaling crystalline silica sand can cause silicosis, lung cancer, and breathing problems to exposed persons.

Slags can contain trace amounts of toxic metals such as arsenic, beryllium, and cadmium and have the potential to cause lung disease.

Be sure to obtain a Safety Data Sheet (SDS) for the chosen blasting abrasive and identify the potential for any hazardous substances.

Selecting an Abrasive

Caution:

Use abrasives or media specifically manufactured for blasting. Consider the following information on choosing abrasives carefully as the type of abrasive can affect blasting efficiency, surface finish, and machine integrity. Check local environmental guidelines for potential restrictions of certain abrasive use before blasting. If blasting an unfamiliar surface, test abrasive selection on a small portion of the surface.

Abrasive shape

Angular. This type of abrasive has irregular edges that create a textured surface in the blasting substrate. A textured or anchored surface is ideal for paint or finishes.

Round. Smooth edges on a rounded shape abrasive will leave a surface smooth. When the goal of blasting is to clean a surface without needing to create texture, a smooth shape will give the desired profile.



ANGULAR



ROUND

Abrasive size, density, and hardness

Size. Most abrasives, or media, are measured by their mesh size. An abrasive's mesh size is defined by the number of holes in a screen the media can pass through per square inch. Refer to Figure 2 for a visual representation of common mesh sizes.

	Looks Like
20/40	
40/70	
60/100	

Figure 2. Common mesh sizes

Density. Knowing the weight or bulk density of an abrasive can help an operator choose the appropriate abrasive for the job. The density is measured in pounds per cubic foot, so an abrasive with a bulk density of 75 lb/ft³ is less dense than a sample of 145 lb/ft³. The higher the bulk density, the more impact the abrasive will have on the blasted surface.

Hardness. Generally, a harder abrasive will impact the blasted surface profile more than a softer abrasive. A softer media, such as organic materials and plastics, is sufficient for removing dirt, oil, grease, and paint without damaging the target surface. An abrasive's hardness may be measured in a couple ways. A common quantitative figure comes from the Mohs hardness scale. The media will fall on a scale of 1-10. 1 being the softest media and 10 being the hardest.

Note: Choosing a coarser media will not always increase productivity. The user should consider mesh size, density, and hardness of an abrasive when factoring productivity and end surface goal.

Media Comparison Charts

Selecting the appropriate abrasive for the job is important to maintain efficiency, conserve media, and protect the integrity of the blasted surface. Figure 3 and Figure 4 below show a few examples of potential media an operator may choose to use. Dry blasting specific media cannot be used in wet blasting as the listed abrasives do not sink in water, a key parameter for successful wet blasting.

The below figures are arranged from most dense to least dense media. Additionally, each abrasive has a listed hardness value, surface profile, surface removal ability, and velocity (how fast or slow the media travels from the blast pot) description.

Figure 3. Dry Blasting Abrasive

	Description	Bulk Density	Hardness	Surface Profile	Surface Removal	Velocity
Sugar Sand	Round media used for cleaning and stripping	100 lb/ft ³	6 – 7	High etch	Yes	Medium fast
Sodium Bicarbonate	Medium-sized abrasive, creates a smooth surface when stripping	61 lb/ft ³	2.5	No etch	No	Slow
Walnut Shells	Angular, organic for mildly powerful stripping without damage to the blast surface	50 lb/ft ³	4.5 – 5	Low etch	Very slight	Medium slow
Corn Cob	Organic, soft media ideal for soft surfaces like wood	40 lb/ft ³	4 – 4.5	No etch	No	Slow

Figure 4. Wet or Dry Blasting Abrasive

	Description	Bulk Density	Hardness	Surface Profile	Surface Removal	Velocity
Steel Grit	Angular for fast stripping and aggressive cleaning	260 lb/ft ³	40 – 65 HRC	High etch	Moderate	Medium fast
Steel Shot	Spheres designed for polishing and peening	230 lb/ft ³	40 – 51 HRC	No etch	No	Medium
Aluminum Oxide	Sharp, long lasting media for fast etching and profiling	110 lb/ft ³	8 – 9	High etch	Yes	Fast
Blast Sand	Angular, sharp edges to cut into the surface and leave an anchor profile	100 lb/ft ³	7	High etch	Yes	Medium fast
Crushed Glass	Free from crystalline silica, 100% recycled glass, efficient, cost-conscious	100 lb/ft ³	5 – 6	Medium-high etch	Slight	Fast
Glass Beads	Round, soda-like glass produces a bright, satin finish.	95 lb/ft ³	5 – 6	No etch	Slight	Medium fast
Silicon Carbide	Hard, powerful cutting media, ideal for stone, glass, and tough surfaces	90 lb/ft ³	9 – 9.5	Very-high etch	Yes	Very fast
Garnet	Angular, hard media commonly used in place of silica sand	85 lb/ft ³	7.5 – 8.5	Very-high etch	Yes	Very fast
Coal Slag	Angular byproduct of coal, used for removal of coatings from steel and concrete	85 lb/ft ³	6 – 7	High etch	Yes	Medium fast
Plastic Abrasives	Soft media for automotive and aerospace applications	50 lb/ft ³	3 – 4	No etch	Slight	Medium

Abrasive Fill Levels

Note: The DB500[®] has a maximum hold of:

- 20 gal of clean water
- 200 lb of abrasive (~40/70 mesh size)
- 28 oz of Rust Inhibitor

The blast pot does not require a maximum fill for operation. If the maximum fill is not needed for a job, fill the machine according to estimated blast time. Use Figure 5 below for an approximate reference.

	Blast Time	Water	Abrasive	Rust Inhibitor
DB150[®]	~15 min	5 gal	50 lbs	7 oz
DB225[®]	~30 min	10 gal	100 lbs	14 oz
DB500[®]	~60 min	20 gal	200 lbs	28 oz

Figure 5. Fill guide for blast pots

III. PREPARING TO BLAST

Personal Protective Equipment



DANGER: Failure to maintain proper PPE can result in the serious injury or death of the operator or bystanders. Loud noise generated by blasting can cause hearing damage. Everyone in the area must use proper hearing protection. It is the employer's responsibility to train employees to identify hazardous substances and to provide suitable policies, procedures, monitoring, recordkeeping, and PPE.

The Occupational Safety and Health Administration (OSHA) recommends abrasive blasting operators wear the following PPE while working:

- Hearing protection
- Eye and face protection
- Helmet
- Leather gloves that protect to full forearm and aprons (or coveralls)
- Safety shoes or boots

Additionally, operators and support personnel in the blasting area should wear proper respiratory protection.



DANGER: Breathing air must meet OSHA class D standards. Using a breathing air source that does not meet class D standards can cause asphyxiation and death. Be sure to use a high-temperature alarm and carbon monoxide monitor. Always make sure the respirator hose is not connected to a line that supplies non-breathable gasses. Before breathing air, be sure to test the content of the respirator line. Failure to follow these procedures can result in serious injury or death to the user.

Respirators should:

- Cover the head, neck, and shoulders
- Be approved by the National Institute for Occupational Safety and Health (NIOSH)

Masking and Containment

Masking

Cover or mask off items such as glass, chrome, rubber seals, wiring, electrical, or moving mechanical parts that look delicate or should remain clean and dry. Tape is a good solution for covering small pieces and parts.

Containment

Capture the blasting byproducts using a heavy tarp. Be sure to weigh down the corners of the tarp for efficient containment.

Model DB500[®]

The figures below show commonly referenced parts of the DB500[®] blast pot mentioned in this manual.

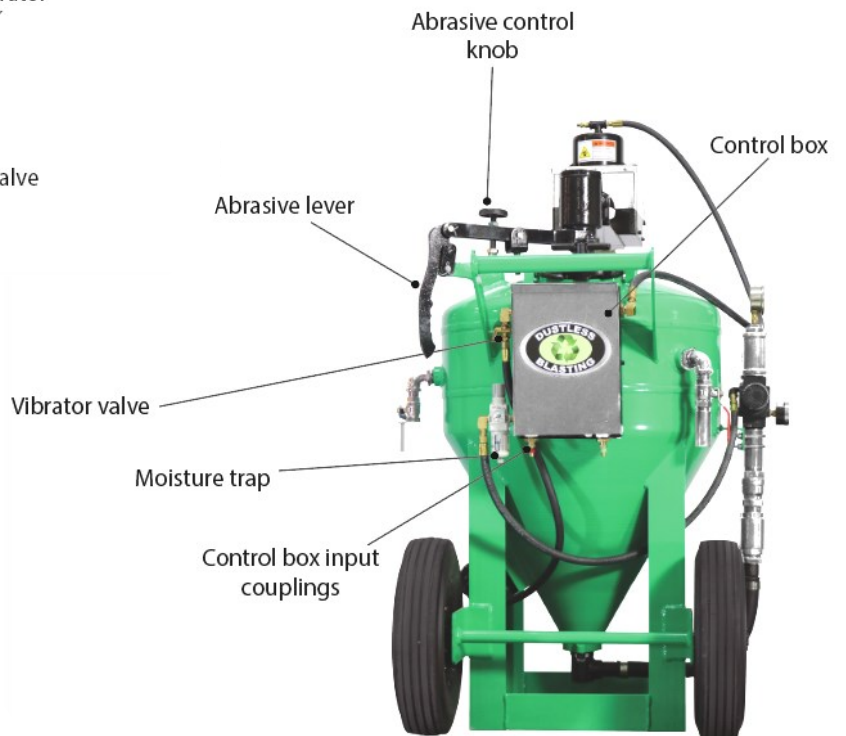
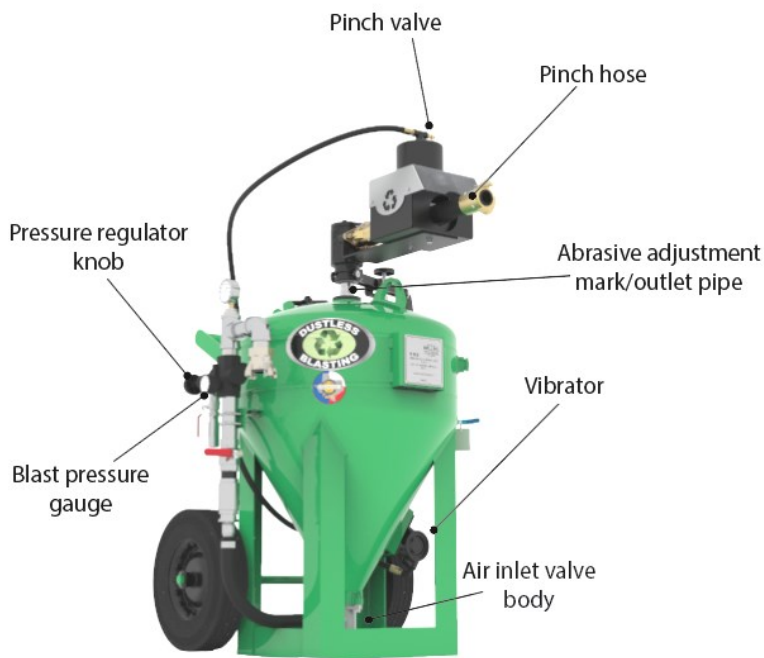
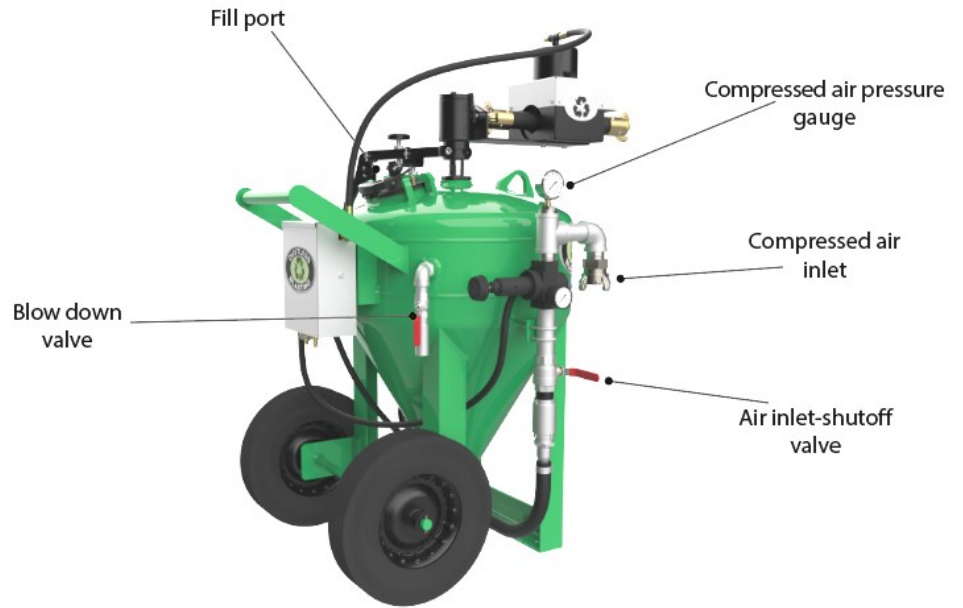

IV. BLAST POT START UP

i. Connect the Blast Hose, Compressor Air Hose, and Lines to the Blast Pot

- 1 Attach the blast hose to the pinch hose at the top of the blast pot and insert the safety pins.

Caution:

When selecting the most productive nozzle for the job, there are two main points to consider. Check what volume of air the compressor in use can supply per minute (CFM) and the desired nozzle pressure (PSI) to maintain during blasting. Be sure to choose the appropriately sized nozzle for a specific compressor and job to avoid unnecessary damage to the equipment or blasted surface.



- 2 Screw on the appropriate blast hose nozzle. The nozzle size is based on the air compressor size.

- 3 Connect the compressor air hose to the compressed air inlet and insert the



- 4 *Pneumatic blast pot.* Fasten the twin line to the control box

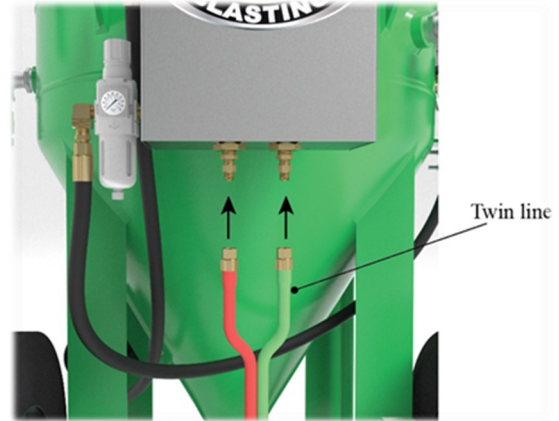

Note: Be sure to connect the twin line to the control box matching red to red and green to green

- 4 *Electric blast pot.* Connect the electric line of the red head controller to the corresponding plug on the control box. Attach the provided alligator clips to a battery with 12v DC power. Then connect the alligator clip line to the adjacent plug on the control box.



ii. Fill the Blast Pot with Abrasive and Water



DANGER: Do not use abrasives with more than one percent crystalline silica. Breathing crystalline silica dust can cause silicosis, a potentially fatal and damaging lung disease. Refer to the abrasive's Safety Data Sheet (SDS) to identify potentially toxic substances in the media. Always wear appropriate NIOSH-approved respirators throughout the blasting process to help prevent potential serious injury or death.

Do not attempt to remove the fill cap on a pressurized machine.

- 1 Remove the fill cap by pulling up on the fill cap handle and turning the cap counterclockwise



- 3 Pour in a predetermined amount of abrasive.

Note: If Rust Inhibitor[®] is needed, add it to the blast pot at this time.

- 4 Remove the funnel and replace the fill cap.

Note: For detailed information on choosing the appropriate abrasive type and amount for the job, see section II of this manual.

- 2 Place the fill funnel into the pot opening and pour in a premeasured amount of clean water.

Caution:

Use the provided media filter to reduce the likelihood of clogging. Debris in the system can damage the machine.



iii. Turn on the Compressor

Caution:

Reference the instruction manual for the selected compressor model before operating.

- 1 Allow the compressor to idle and warm up for about 15-30 seconds.

iv. Pressurize the Blast Pot

Caution:

Pressurize the blast pot before starting the active blasting process. When the machine pressurizes, the abrasive lever on the blast pot will pop up. Adjust the operating pressure based on project goals. For more information on tuning blast pressure, see subsection “Adjusting Operating Pressure” of this manual.

Open the air inlet-shutoff valve slowly to prevent damage to the machine from too much compressed air flowing in at one time. The air inlet-shutoff valve and the blow down valve will be in opposite positions.

- 1 Pull up on the abrasive lever to move the handle into the unlocked position.



- 3 Slowly open the air inlet-shutoff valve.



Closed Position



Open Position



- 2 Close the blow down valve.



Open Position



Closed Position

- 4 To prevent build up of moisture, loosen the screw at the bottom of the filter regulator on the left of the control box and slightly open the moisture trap valve.

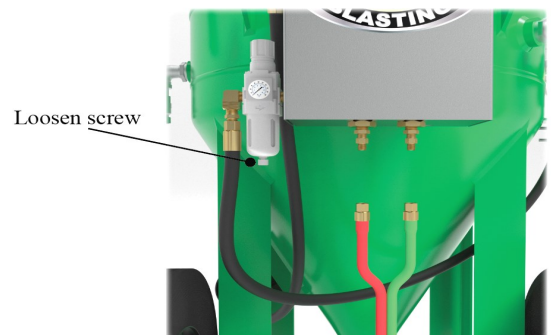

V. ACTIVE BLASTING



Danger: Uncontrolled blast stream and high-velocity abrasive particles can inflict serious injury. Always maintain nozzle control and point the blast nozzle in the direction of the blast surface only. Make sure the blast hose is securely fastened to prevent detaching during operation. Keep unprotected workers out of the blast area.

Ensure proper PPE is secure and in place.

Never attempt to bypass the safety controls on either the pneumatic or electric blast pot.

Do not leave a blast pot unattended. If there is an emergency, shut the machine down immediately.

Warning:

To avoid injury to the operator and damage to the machine, check the pinch hose is properly maintained before beginning the active blasting process. Use caution when connecting power to an electric blast pot control.

Begin Blasting

- 1 Check the abrasive lever is still in the unlocked position.
- 2 Make sure the operating pressure is adjusted for optimal project-based performance.
- 3 Adjust the vibrator valve so the blast pot is at maximum vibration.
- 4 Start the active blasting process. Based on the type of blast pot, the handle activation will vary. See the diagrams below and follow the instructions based on the type of handle included with the pot.

Pneumatic blast pot handle. To activate the blast hose, depress the safety button on the side of the deadman controller and slowly press the handle on the top of the control.

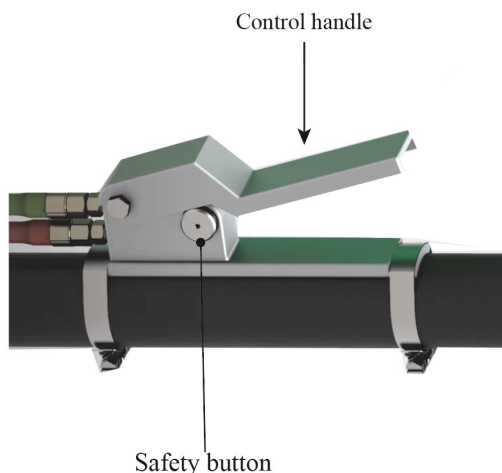

Electric blast pot handle. Slowly press the toggle switch of the redhead electric deadman controller.

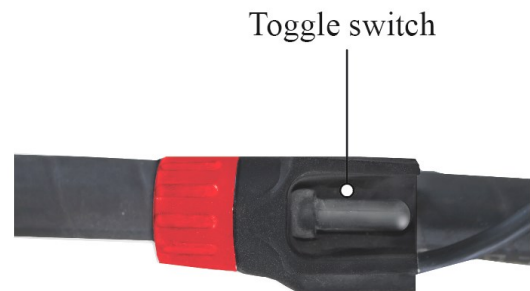

Note: For best results, try different blast patterns and angles to find the proper workflow.

VI. BLAST POT SHUT DOWN

Caution:

DO NOT turn off the compressor when starting the shut down process. Failure to leave the compressor running will cause a backflow of air, water, and media into the system and damage the machine.

- 1 While the compressor is running, close the air inlet-shutoff valve.



Open Position



Closed Position

Keep compressor running

- 3 Let the pot fully depressurize before turning off the compressor.

- 2 Open the blow down valve to release the pressure in the blast pot.



Closed Position



Open Position

VII. IN PROCESS ADJUSTMENTS

There are three recommended areas of adjustment to aid in an efficient blasting process.

- Abrasive flow rate
- Blasting pressure
- Stand-off distance

Adjusting Abrasive Flow Rate

The desired flow rate of media from the blast pot may change from surface to surface. There are adjustments that can be made throughout the blasting process to maximize media flow rate.

Increasing media flow

- 1 Make sure the abrasive lever is all the way down in the locked position.
- 2 Increase the amount of abrasive in the blasting output by turning the abrasive valve in quarter-turn, counterclockwise increments.

Note: Each quarter turn raises the outlet pipe 1/16" of an inch, allowing more media and water to flow from the blast pot.

- 3 Test the effectiveness of each quarter turn on the blasted surface.

Caution:

Do not bypass the safety sleeve when adjusting the height of the outlet pipe.

Note: The media flow rate has been fully adjusted once the removal rate fails to increase.

- 4 Once the desired result is achieved, secure the outlet pipe in place with the locking nut.



Decreasing media flow

- 1 Fully depressurize the blast pot before decreasing media flow.
- 2 Decrease the amount of abrasive in the blasting output by turning the abrasive valve in quarter-turn, clockwise increments.

Adjusting Operating Pressure

Finding the optimal pressure is important for maximizing operator efficiency while protecting the blasted surface.

To adjust the pressure:

- Rotate the pressure regulator knob clockwise to increase the pressure.
- To lower the pressure, rotate the pressure regulator knob counterclockwise.

Note: When lowering the pressure while the blast tank is pressurized, be sure to release some pressure by blasting the excess or opening the blow down valve slightly until pressure is released.

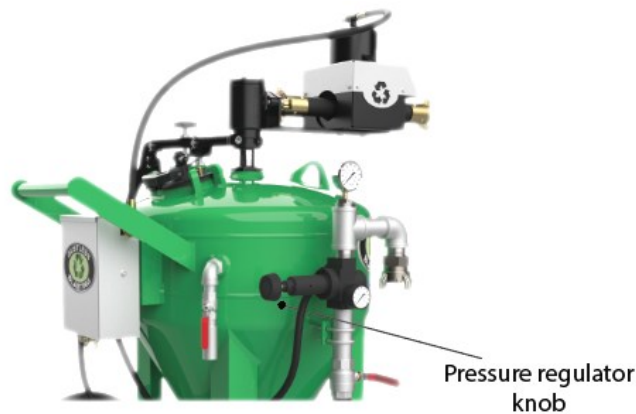

Adjusting Blast Distance

The distance the operator holds the blast nozzle from the targeted surface affects the power, speed, and blast pattern of the job. Holding the blast nozzle too far from the work surface will create a larger, less efficient pattern. Inversely, the nozzle too close to the blasted surface will give a small, overly powerful blast pattern.

Find the right balance between blast pattern and removal speed by adjusting how close or far the blast nozzle is to the work surface.

Note: Adjust the blast nozzle so the media stream is hitting the surface at a 45-degree angle for a more efficient technique. If you need to move the blast pot closer to the blast target, lengthen the compressor air hose rather than the blast hose to preserve sufficient blast pressure.

VIII. TRANSITIONING FROM WET TO DRY BLASTING

Caution:

The DB500® is suitable for wet and dry blasting. To dry blast, an air drying and cooling system is required.

To prepare the blast pot for dry blasting:

1. Blast all media and water out of the machine.

Note: See the manual for the selected air drying and cooling system for more information on start up/shut down procedures.

2. Remove the fill cap.
3. Connect the air cooling and dryer system to the compressor and turn on the fan.
4. Open the air inlet-shutoff valve halfway and let the air circulate through the blast pot for five to seven minutes, or until completely dry.
5. Place the fill cap back in the blast pot and pressurize the tank.
6. Run air through the machine as if blasting for two to three minutes.
7. Inspect the pot's tank to make sure there is no residual moisture.
8. Once all moisture is gone, fill the blast pot with one bag of dry blasting suitable abrasive.

Caution:

Turn the vibrator valve off on the blast pot when dry blasting to avoid media clogging at the bottom of the machine.

Machine Transportation



DANGER: Make sure the blast pot is empty and the abrasive lever is locked before attempting to transport the machine. Use lift equipment that is suitable for weight heavier than the machine and attachments. Securely attach the machine to transportation device such as a pallet or vehicle. The intended mover of the machine must be knowledgeable of the risk and trained in moving heavy machinery. Failure to consider these risks can result in injury or death.

Moving the Blast Pot



DANGER: Do not move the blast pot on an incline, slippery, or irregular surface. Weight shifts can cause a machine to become unsteady and operator may lose control. This can cause serious injury and death. Be sure to move the blast pot and accessories in a controlled manner. Empty the blast pot before attempting to move it.

IX. MACHINE STORAGE

When leaving a blast pot idle for long periods of time, be sure to completely blast the water and media out of the tank or follow the storage procedure below. See Figure 7 and 8 in the “Flushing the Blast Pot” section of this manual for a visual representation of the procedure below.

1. Fully depressurize machine by opening the air inlet-shutoff valve and closing the blow down valve.
2. Remove both air inlet body lugs and air inlet body lug bolts from the underside of the blast pot. See Figure 7 in "Flushing the Blast Pot."
3. Remove the air inlet jet and gasket. See Figure 8 in "Flushing the Blast Pot."

Note: If the air inlet jet is difficult to remove, raise the abrasive lever to assist in pulling the jet out of the blast pot. If the abrasive lever is difficult to raise, make sure there is no settled media at the bottom of the blast pot.

4. Push the air inlet body and air hose out of the way.
5. Flush out inside of equipment with water.
6. Once finished, replace the gasket, inlet jet, and lugs and bolts.

Storing the Machine in Cold Climate

Caution:

To avoid machine damage from freezing temperatures, be sure to take the following precautions.

Loosen all of the ball valves on the unit to prevent residual moisture from expanding in the valve.

Blasting in Freezing Temperatures

When the temperature is at or below freezing, the following information can help keep the blast pot running.

1. At or below freezing temperatures, add rubbing alcohol to the water tank at a 1:100 rubbing alcohol to gallons of water ratio. If more rubbing alcohol is needed, the concentration ratio go can up to a maximum of 1:20.
2. Arrange a protective tent around the pot, pump, and moisture separator and place a heater inside to warm the materials.
3. Be sure to empty the tank and blow out hoses to prevent freezing

X. MAINTENANCE



DANGER: Do not attempt maintenance on a pressurized machine.

Control Box

Pressure regulator

The control box's pressure regulator comes factory set at 80 PSI. Make sure to adjust the regulator until the PSI is back at 80 if the pressure is ever changed.

Caution: Do not attempt to change the PSI of the control box's pressure regulator from 80 PSI.

Control box Parker valve

The control box Parker valve is due for service when the shutoff time is longer than usual or the valve is not actuating properly.

To service the control box Parker valve:

1. Depressurize the machine.
2. Remove screws A and B from the front panel of the control box and remove the cover.
3. Remove screws C and D from inside the control panel to access the valve and end caps.
4. Label each end cap left or right respectively to ensure they're returned to the same spot.
5. Remove the end caps by unscrewing the two screws on each side.
6. Inspect the spring and gaskets of each end cap for signs of wear.
7. Using a long tool, such as the body of a screwdriver, push the piston out of the black box and inspect the six O-rings for wear.
8. If all the O-rings are in proper condition, lightly lubricate the rings with lithium grease.
9. Re-insert the piston and make sure the gaskets and spring are sitting properly before attaching the end caps.
10. Place the cover back on the control box.

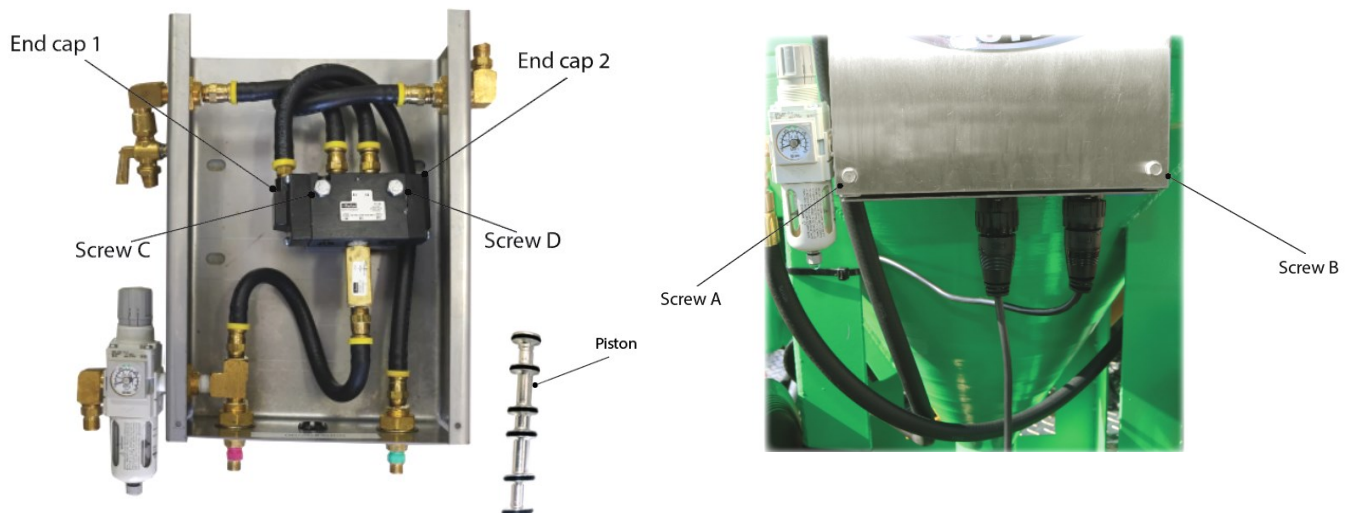

Blast Pot Pressure Regulator

Be sure to periodically lubricate the threads on the pressure regulator knob with a lubricant such as lithium grease.

Filter Regulator

The filtered moisture and debris will collect at the bottom of the regulator if not vented through the screw. Leave the screw open slightly to let the moisture out continuously.

Blast Hose



DANGER: The blast hose, couplings, and nozzle holders should be adequately sized for the abrasive blast application. Always utilize coupling safety pins and accessories. Ensure all blast hose couplings and nozzle holders are fitted with the correct size coupling gasket or nozzle washer. Inspect the blast hose and accessories for wear before attempting to blast.

Inspect the blast hose and couplings daily for signs of wear or leaks. Check for soft spots by squeezing the hose about every six inches. Look for holes, cracks, and disintegration of the outer casting. If there are multiple soft spots, holes, or general wear, replace the blast hose.

An additional sign of wear is bubbling of the hose as seen in Figure 6. This can cause the hose to burst. If there are signs of bubbling present, replace the blast hose immediately. Do not try to blast.

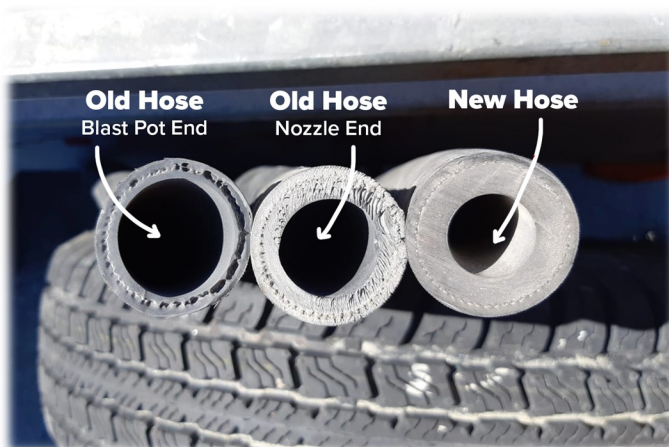

Figure 6. Bubbling in a blast hose

General Blast Pot Maintenance

Flushing the Blast Pot

Regularly flushing the pot avoids potentially damaging buildup from accumulating on the walls of the machine. About once a month, follow the procedure below to properly flush the blast pot.

1. Fully depressurize machine by opening the air inlet-shutoff valve and closing the blow down valve.
2. Remove both air inlet body lugs and air inlet body lug bolts from the underside of the blast pot. See Figure 7 below.
3. Remove the air inlet jet and gasket. See Figure 8 below.

Note: If the air inlet jet is difficult to remove, raise the abrasive lever to assist in pulling the air inlet jet out of the blast pot. If the abrasive lever is difficult to raise, make sure there is no settled media at the bottom of the blast pot.

4. Push the air inlet body and air hose out of the way.
5. Flush out the inside of the equipment with water.
6. Once finished, replace the gasket, air inlet jet, lugs, and bolts.

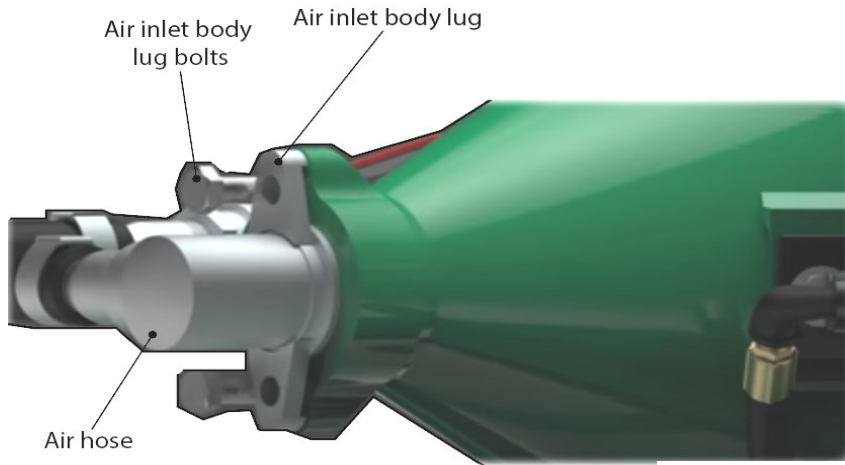

Figure 7. Underside of the blast pot

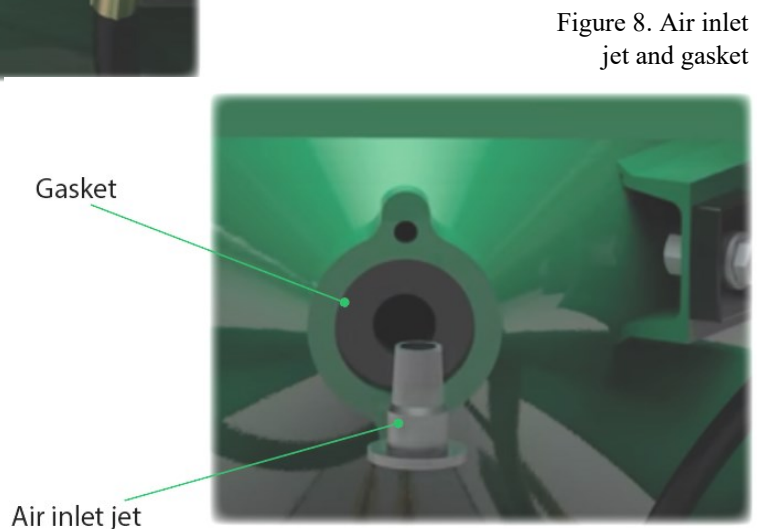









Figure 8. Air inlet jet and gasket

Blasting Wear Parts

Certain parts wear faster than others and will require regular maintenance and inspection depending on the method and abrasive used to blast. These items should be inspected for damage or wear weekly.

Note: Depending on how much dry blasting is done, these parts may have to be replaced sooner or later than the recommended time.

<p>Outlet elbow insert</p>	
<p>Outlet elbow insert gasket</p>	
<p>Elbow cap gasket</p>	
<p>Air inlet jet</p>	
<p>Air inlet jet gasket</p>	
<p>Pinch hose coupling with screws</p>	
<p>Hardened pipe</p>	
<p>Blast nozzle</p>	

Pinch Hose Maintenance

Warning:

Make sure to completely replace the pinch hose after about 40 hours of use or four rotations. When replacing the hose, make sure there is a flush square cut. Failure to do so could result in pinch hose malfunctioning. A dysfunctional pinch hose can result in operator or bystander injury.

Using the Pinch Hose

Rotate the pinch hose every 10-15 hours of blasting. See Figure 9 and 10 on how to rotate the pinch hose. Perform a visual and physical inspection to ensure integrity. Look and feel for signs of wear, softness, or bulges.

In the approximate 40 hours of life for the pinch hose, there are four different positions the hose will move through.

- Starting position
- Flip the hose front to back.
- Rotate 180°
- Flip the hose front to back one more time.

After these four positions, it is time to replace the hose.

Note: Do not reuse any of the four different pinch hose positions after it's allotted 10-15 hours of use.



Figure 9. Flipping the pinch hose



Figure 10. Rotating the pinch hose

Removing the Brass Couplings From an Old Hose

1. Remove the screw on the coupling using a Phillips head screwdriver or drill.
2. Unscrew the brass coupling from hose turning counterclockwise. A bar or rod may be needed to loosen this piece.

Attaching the Brass Couplings to the New Pinch Hose

1. Wrap the end of the hose in several layers of friction tape, slightly beyond the point the brass will cover.
2. Place the coupling over the friction tape and hose, screwing clockwise until the hose end pushes against the inside brass ridge of the coupling. A bar or rod may be used to secure the piece in place.
3. Wrap the screws with Teflon tape and screw into their designated holes until tight.

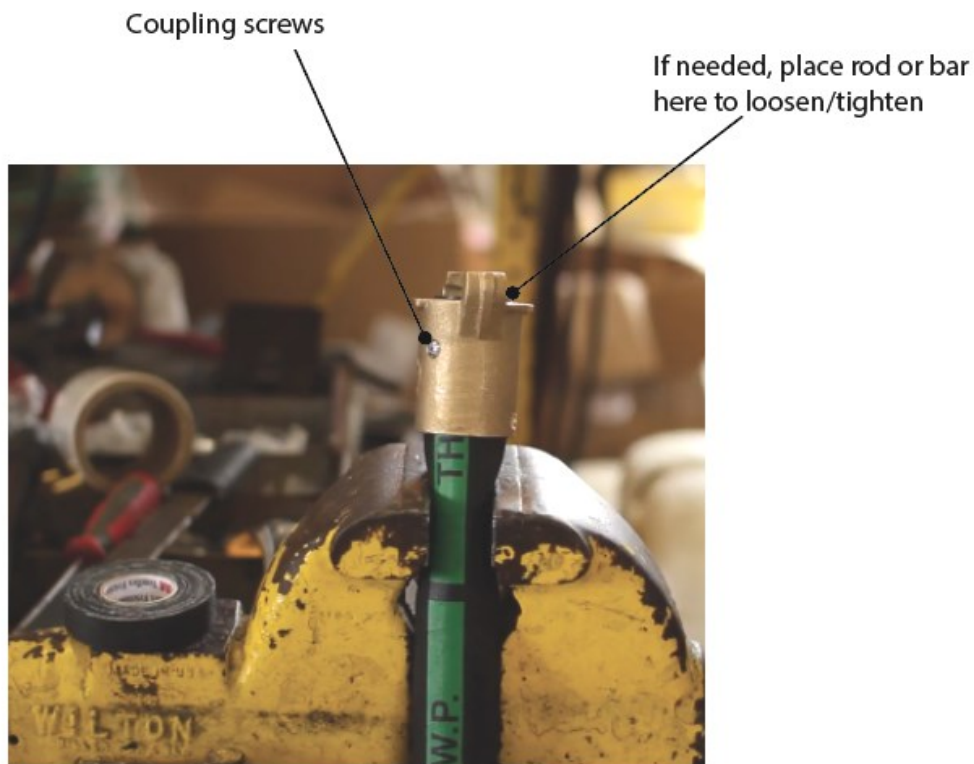

Preventative Maintenance

The following daily, weekly, and monthly maintenance suggestions should be used as a general guide only. Comprehensive maintenance will vary for each machine.

Daily Maintenance

The operator should perform daily checks on all parts of their machine to ensure safety and operational ability of components.

MMLJ Parts

- Inspect the pinch hose.
- Inspect the blast hose.

Note: Check for soft spots by squeezing the hose about every six inches. Look for holes, cracks, and disintegration of the outer hose casing. If there are several soft spots, holes, or general deterioration, it's time to replace the hose.

- Ensure the filter regulator is cracked open so moisture can properly drain.
- Ensure the moisture trap drain is cracked open.
- Inspect all gauges.
- Ensure gauges are at 0 when the machine is not in operation.

Weekly Maintenance

General parameters for checking the items below is about every ten hours.

MMLJ Parts

- Rotate the pinch hose.
- Check the torque on the water pump bolts.
- Inspect the blast hose.

Note: Check for soft spots by squeezing the hose about every six inches. Look for holes, cracks, and disintegration of the outer hose casing. If there are several soft spots, holes, or general deterioration, it's time to replace the hose.

- Inspect the blast nozzle and the nozzle holder.
- Check the filter regulator for wear.

Monthly Maintenance

General parameters for checking the items below is about every 40 hours.

MMLJ Parts

- Replace the pinch hose monthly, or after it has been rotated four times.
- Lubricate the threads of the pressure regulator knob with a lubricant such as lithium grease.
- Inspect and lubricate the Parker valve in the control box.
- Inspect the fill cap gasket, and clean or replace if necessary.
- Flush out the blast pot to prevent rust or buildup from accumulating inside.
- Check the filter regulator for wear.

For assistance with servicing your machine:

www.dustlessblasting.com/owner-support

For replacement parts and accessories:

store.DustlessBlasting.com

For training resources:

support.DustlessBlasting.com

To submit a ticket, find Safety Data Sheets, business guides, authorization certificates, and warranty information:

www.DustlessBlasting.com/support

XI. TROUBLESHOOTING

Media Buildup Inside the Blast Pot

Adjust the vibrator valve

On the left side of the control box, a small brass petcock valve controls the vibrator speed. Make sure this vibrator valve is open during active blasting and adjusted until there is maximum vibration of the machine head. This will ensure all of the media collects at the bottom of the tank and is able to be blasted from the pot when wet blasting. Keep the tank clear of media buildup to ensure proper machine functionality.

Abrasive Flowing Incorrectly

Check installation and air pressure

Before continuing troubleshooting, make sure the blast pot is properly installed and is operating at the appropriate air pressure.

Check media quality

If the pot was installed correctly with sufficient air pressure and proper abrasive, next check the quality of the media used. If the abrasive is not properly suited for blasting,

Nothing Coming from the Blast Nozzle

The blast nozzle may become clogged with debris or blast media. If this occurs, close the air inlet-shutoff valve, open the blow down valve, remove the nozzle, and check for a rock or other foreign material.

Pinch Valve is Not Opening or Closing (Electric)

Caution:

Open the blow down valve and close the air inlet-shutoff valve before beginning the process below.

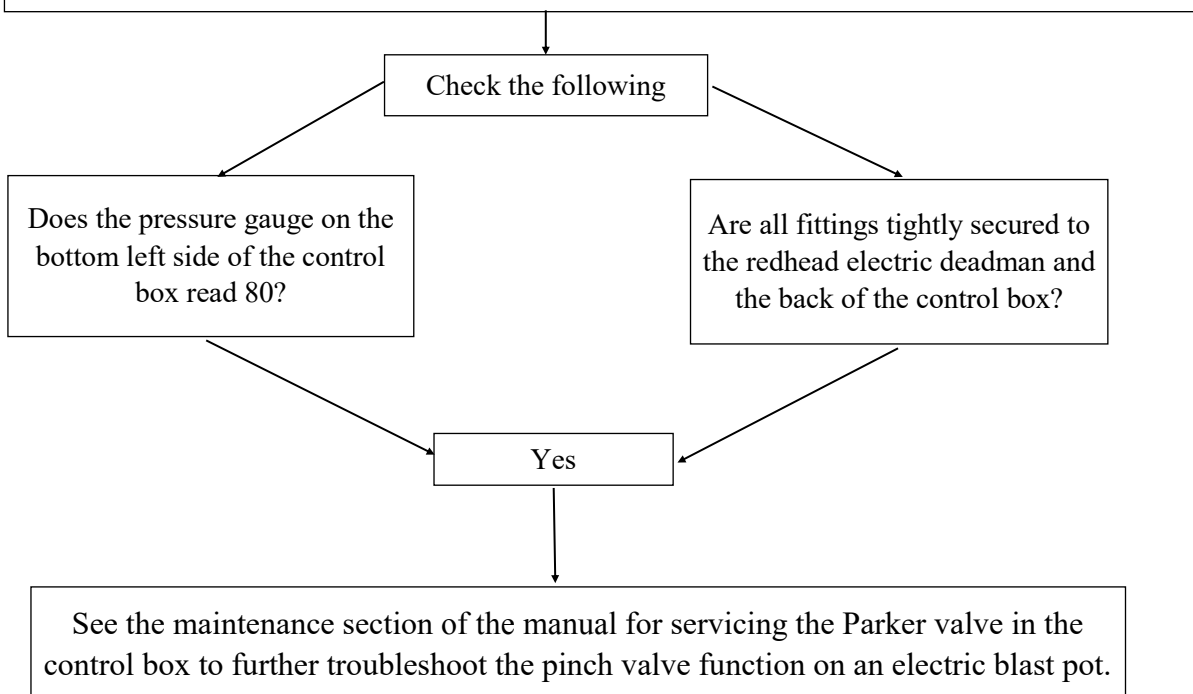

Pinch Valve is Not Opening or Closing (Pneumatic)

Caution:

Open the blow down valve and close the air inlet-shutoff valve before beginning the process below.

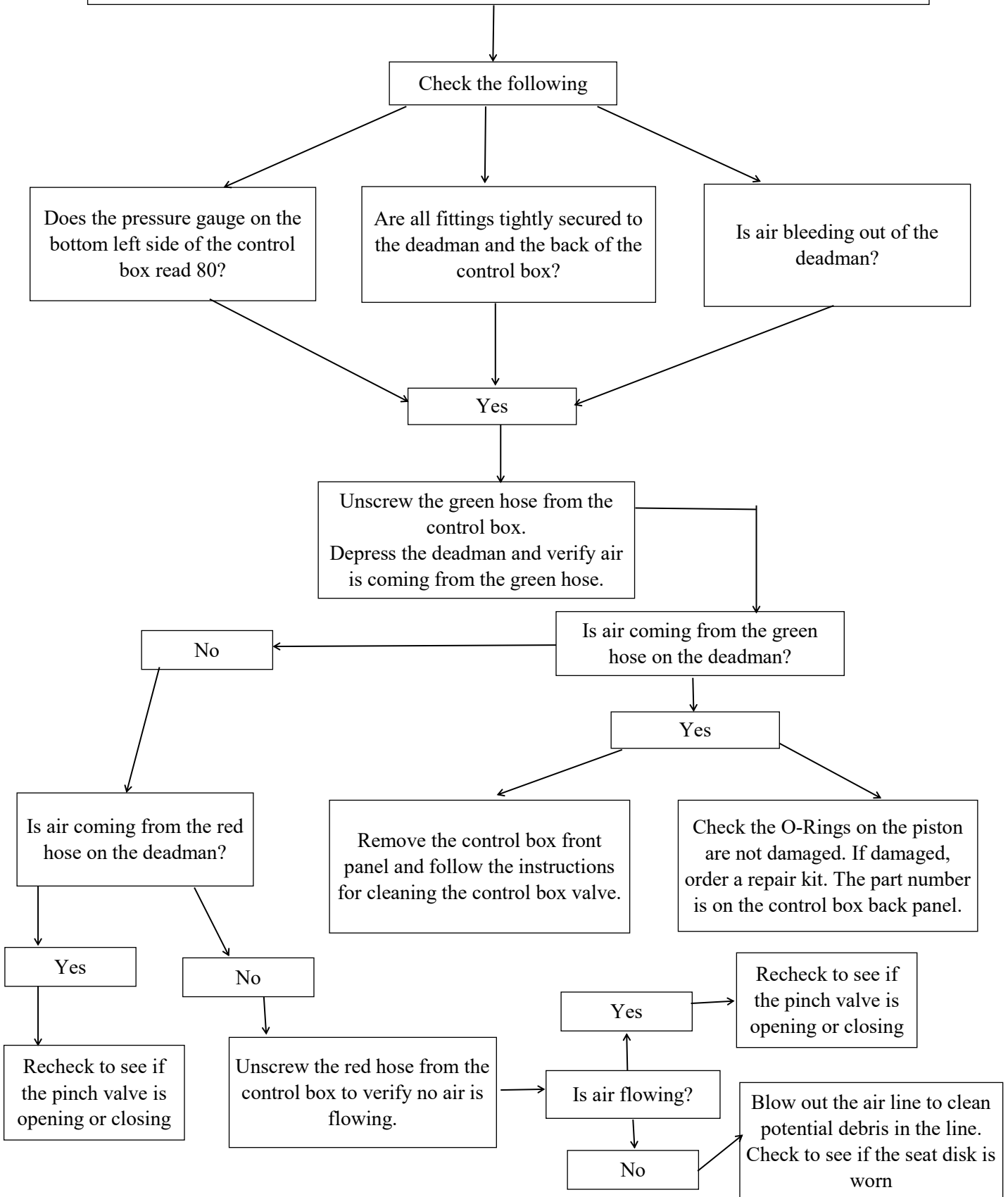

XII. APPENDIX

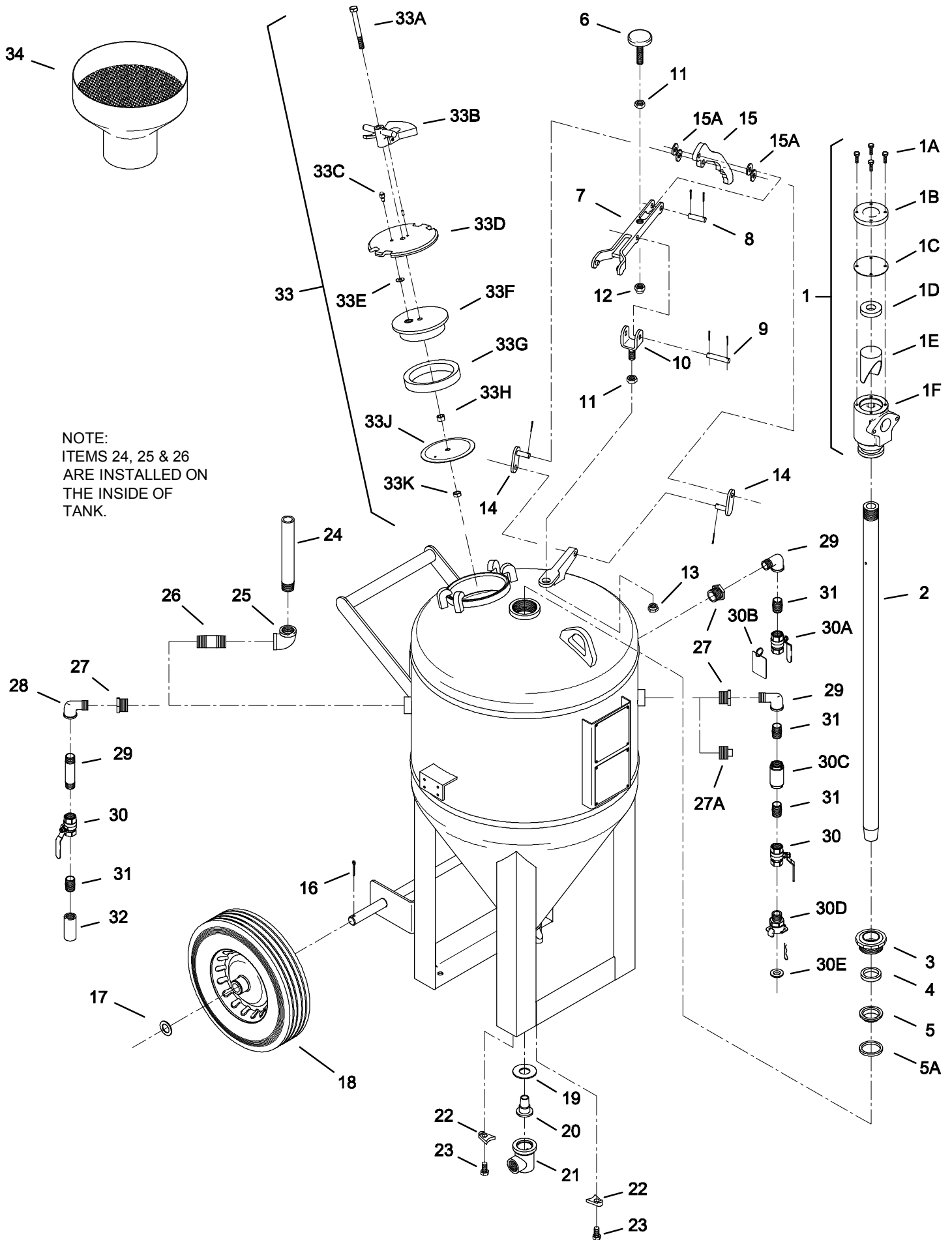

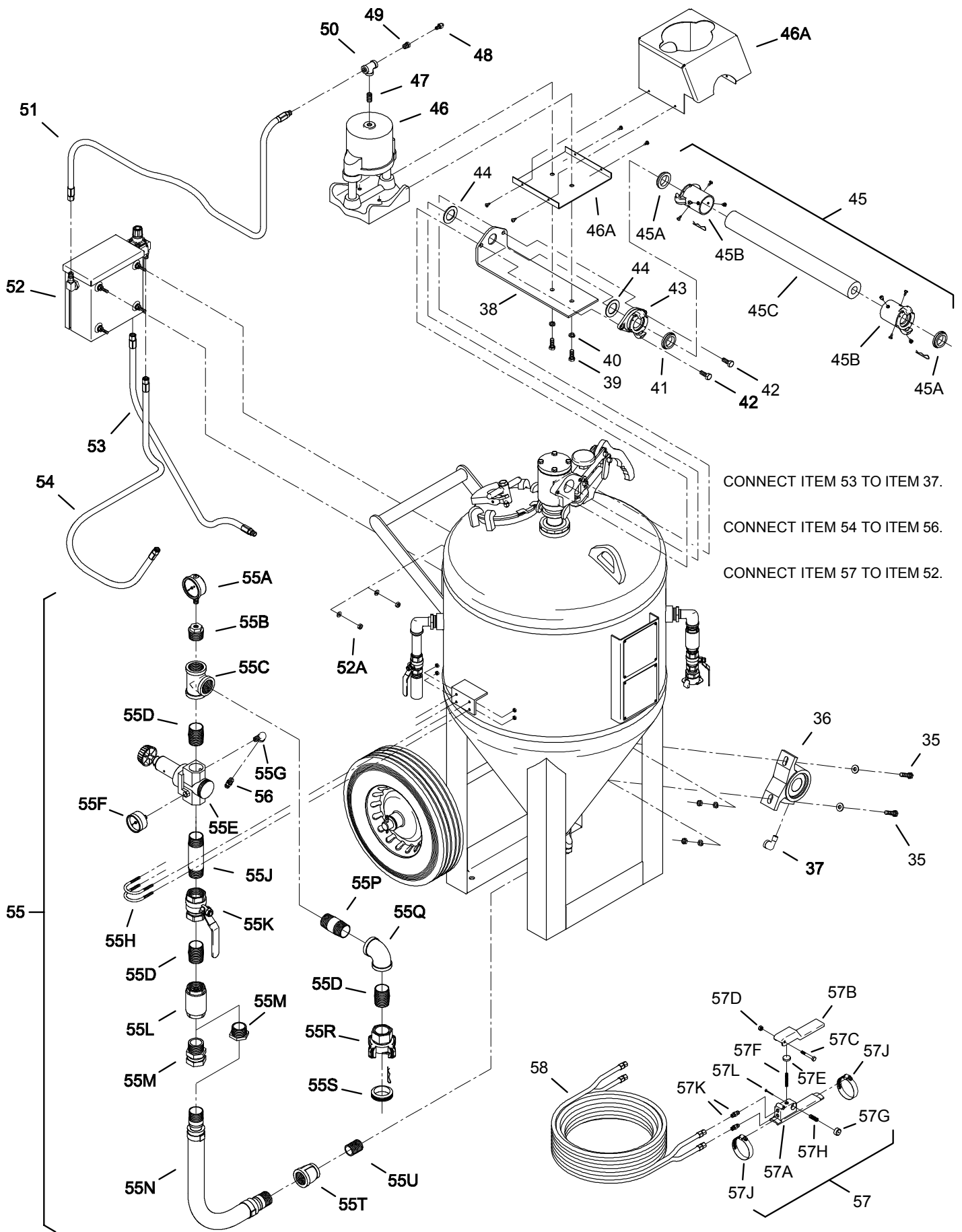

<i>Item No.</i>	<i>Description</i>	<i>Part No.</i>	<i>Stock No.</i>	<i>Qty.</i>
1	Outlet Elbow Assembly Complete	M-17	72856/001	1
1A	Outlet Elbow Cap Bolts (4)	M-17-D	82563/001	1
1B	Outlet Elbow Cap	M-17-C	131054/001	1
1C	Outlet Elbow Cap Gasket	M-17-G	131227/001	1
1D	Outlet Elbow Insert Gasket	M-23-G	131147/001	1
1E	Outlet Elbow Insert	M-23	73602/001	1
1F	Outlet Elbow Body	M-17-B	80788/001	1
2	34-1/2" Outlet Pipe (DB-500)	500-2	134613/001	1
3	Packing Gland Nut	M-5-1	131102/001	1
4	Gasket	M-13	131226/001	1
5	Coupling Gasket	M-5-G	131225/001	1
5A	Seal (manufactured after 5/15/13)	M-6-S	131226/002	1
6	Rocker Arm Adjusting Screw	AB-8	73464/001	1
7	Rocker Arm	B-3-1	73480/001	1
8	Abrasive Lever Clevis Pin w/ Cotter Pins	AB-11-S	731070/001	1
9	Pedestal Clevis Pin w/ Cotter Pins	AB-12-S	131069/001	1
10	Rocker Arm Hinge Yoke	AB-75	131113/001	1
11	Pedestal Locking Nut/Fill Cap Hold-Down Screw Locking Nut	AB-75-C	22926/001	2
12	Rocker Arm Acorn Nut (5/8"-11)		134687/002	1
13	Rocker Arm Hinge Yoke Adjusting Nut	AB-75-E	131094/001	1
14	Connecting Link w/ Cotter Pins		131133/001	1
15	Abrasive Control Lever	AB-9	73500/001	1
15A	Abrasive Control Lever Washers	FBA		4
16	Wheel Cotter Pin	C-33-C	72848/001	2
17	Wheel Washer	C-33-W	72849/001	2
18	Wheel	BF-31-2	133648/001	2
19	Air Inlet Body Gasket	AB-1-G	131228/001	1
20	Air Inlet Nozzle (5/8")	SB-1-NHD	134356/002	1
21	Air Inlet Body	ABHD-1	73478/001	1
22	Air Inlet Body Lug	AB-47	131231/001	2
23	Air Inlet Body Lug Bolts (2)	AB-47-B	23879/005	1
24	1" x 9-3/4" Nipple	FG-68	131400/001	1
25	1" Elbow	AB-61-T	131867/001	1
26	1" x 3" Nipple	AB-61-S	131861/001	1
27	1" x 3/4" Bushing	AB-61-A	131860/001	1
27A	1" Plug (stand alone units only)			2
28	3/4" 90 Degree Street Elbow		131847/001	1
29	3/4" x 4" Nipple	HC-30-N	131392/001	1
30	3/4" Blow-Off Valve (red handle)	AB-61-C	70239/001	2
30A	3/4" Blow-Off Valve (blue handle)		133762/001	1
30B	Safety Tag			1
30C	3/4" Check Valve		133051/001	1
30D	3/4" Crowfoot		132172/001	1
30E	Crowfoot Gasket	M-G-2	73850/001	1
31	3/4" Close Nipple	RC-23	131859/001	1
32	Blow-Off Restrictor	AB-61-R	68967/001	1
33	Fill Cap Assembly	B-60-1	73856/001	1
33A	Bolt	AB-60-A	70241/001	1
33B	Fill Cap handle w/ Safety Lock		131317/001	1
33C	Button Bleeder	BB-1S	69953/001	1
33D	Fill Cap Plate	B-60-D1	131091/001	1
33E	Washer	AB-60-E	285781/001	1
33F	Fill Cap Sleeve	B-60-B	131031/001	1
33G	Rubber Seal RING	B-13-G	73620/001	1
33H	Nut	AB-60-F	77078/001	1
33J	Fill Cap Bottom Plate	B-60-R1	131095/001	1
33K	Jam Nut			1
34	Fill Funnel			1

Item No.	Description	Part No.	Stock No.	Qty.
35	Vibrator Bolt, Washer, Lock Washer & Nut			2
36	Vibrator		133811/001	1
37	1/4" 90 Degree Street Elbow	RC-16	73813/001	1
38	Pinch Valve Plate		134611/001	1
39	Pinch Valve Mounting Bolts (2)			1
40	Pinch Valve Mounting Lock Washers (2)			1
41	KF Series Coupling Gasket	KFG	131148/001	1
42	Elbow Adapter Bolts (2)	KF-17-B	23858/001	1
43	Elbow Adapter, w/ Gasket	KF-17	80790/001	1
44	Elbow Adapter Flat Gasket	KF-17-G	131149/001	1
45	Short Blast Hose Assembly			1
45A	KF Series Coupling Gasket	KFG	131148/001	2
45B	Hose Coupling w/ Screws	KF-4	80837/001	1
45C	1" Blast Hose, Uncoupled		72635/001	1
46	Pinch Valve		74290/001	1
46A	Pinch Valve Safety Cover (complete with screws)			
47	1/4" Close Nipple		77094/001	1
48	Button Bleeder	BB-1S	69953/001	1
49	Brass Bushing	DRC-3-B	73815/001	1
50	1/4" Tee	RC-19	131865/001	1
51	3/8" Air Hose Assembly (Pinch Valve)			1
52	Pneumatic Control Box		133303/500	1
52A	Control Box Mounting Nuts & Lock Washers (2)	FBA		1
53	3/8" Air Hose Assembly (Vibrator)			1
54	3/8" Air Hose Assembly (Air Inlet)		134798/001	1
55	Air Inlet Assembly		134798/002	1
55A	Gauge	SB-30-G	134366/001	1
55B	Bushing	AB-30-IC	131868/001	1
55C	1-1/4" Tee	AB-30-IT	131856/001	1
55D	1-1/4" Close Nipple		131870/001	3
55E	1-1/4" Regulator		132055/002	1
55F	Gauge		70238/001	1
55G	1/4" 90 Degree Street Elbow	RC-16	73813/001	1
55H	U-Bolts w/ Nuts		131585/001	2
55J	1-1/4" x 5" Nipple	AB-30-N	131462/001	1
55K	1-1/4" Ball Valve	V-99	70240/001	1
55L	1-1/4" Check Valve		133040/001	1
55M	1-1/4" x 1" Bushing (DB-500 Only)		131837/001	1
55N	1" Hose Assembly (DB-500 Only)			1
55P	1-1/4" x 3" Nipple		131858/001	1
55Q	1-1/4" Elbow		131855/001	1
55R	Crowfoot			1
55S	Crowfoot Gasket			1
56	Hose Adapter	RC-18	72828/001	1
57	Dual Line Activator Valve Assembly	DR-3-1	83619/001	1
57A	Activator Valve Body	DR-3-1A	83615/001	1
57B	Activator Lever	SDR-3B	83616/001	1
57C	Hex Head Bolt	SDR-3F	78963/001	1
57D	Hex Head Nut	SDR-3G	78968/001	1
57E	Seat Disc	SDR-3E	82617/001	1
57F	Spring	SDR-3D	84067/001	1
57G	Safety Stop	SDR-3H	83618/001	1
57H	Spring	SDR-3S	84098/001	1
57J	Hose Clamps	RCAV-5	72834/001	2
57K	1/8" Hose Adaptor	DRC-3-A	131609/001	2
57L	Round Head Screw	SDR-3J	27030/001	1
58	Dual Line Remote Control Hose	DRC-3-50	72770/001	1



The Future of Surface Preparation®



MMLJ, Inc.
5711 Schurmier Rd.
Houston, TX 77048

Phone: 800-727-5707
International: +1 713-869-2227
Fax: 713-868-8041

Email: support@dustlessblasting.com
www.dustlessblasting.com